



User manual



Multifunctional bench scale

PTS6K-MF	6 kg	d=0.2g
PTS15K-MF	15 kg	d=0.5g

Table of Contents

Instructions for Use	1
Preparing to use the Scale.....	1
Chapter 1 Introduction	3
1-1 Features and Specifications	3
1-2 Display Description	4
1-3 Keypad Functions Description.....	5
1-4 Power Description	5
1-5 Error Messages.....	6
Chapter 2 General Operation Description.....	7
2-1 Backlight Function.....	7
2-2 Weighing Mode	7
2-2-1 Units Selection	7
2-2-2 Check Weighing Mode ⇒ For 12key model	7
2-2-3 Totalizing.....	9
2-2-4 Zero Function	10
2-2-5 Tare Function	10
2-3 Counting Function.....	11
Chapter 3 General Function Setting	12
F 14 ⇒ Printing orders when F 5 is set as r n P 6 or r n P 7.....	12
3-1 F 4 ⇒ Check Weighing Configurations	13
3-2 F 5 ⇒ RS-232 Interface Output Setting (option)	14
3-3 F 6 ⇒ Exit Function Setting Mode.....	20
3-4 F 7 ⇒ Internal Value Display Mode.....	20
3-5 F 10 ⇒ G value Calibration.....	21
3-6 F 11 ⇒ ID Code Setting.....	22
3-7 F 12 ⇒ Print Key () Function Setting.....	23
3-8 F 14 ⇒ Printing orders when F 5 is set as.....	24

To guide you to use our product correctly, please read this User Manual carefully to extend the life of scale and to avoid error.

Instructions for Use

1. Please keep scale in a cool and dry place. Do not store under high temperatures.
2. Please keep the scale clean and free from insect infestation.
3. Avoid impacting with other items or overloaded with excessively heavy weights (The load must not exceed the maximum capacity of the scale).
4. If the scale is not going to be used for some time, please clean it and store it in a plastic bag in dry condition. A desiccant sachet may be included to prevent moisture from building up.
5. Do not mix different types of dry battery or mix used dry batteries with new dry batteries.
6. Please operate or charge the scale in an open area. Do not squeeze the power cord to avoid wire on fire.
7. Operating temperature: $-10^{\circ}\text{C} \sim +40^{\circ}\text{C}$
8. Any suggestion is warmly welcome.

Preparing to use the Scale

1. Locate the scale on a firm level surface free from vibrations for accurate weight readings. Adjust the four leveling feet to centre the leveling bubble on the scale.
2. Avoid hot sunshine directly on the scale or near the exhaust port of ventilating system.
3. Please use a separate power source plug, to avoid the disturbance of other electric appliance.
4. There should be no weight on the scale when power is turned on.
5. Commodity should be placed at the centre of platter when being weighed, and its size should not exceed the dimension of the platter.
6. Please warm the scale 15 ~ 20 minutes before using.
7. Note that when  symbol appears on the screen, the scale needs to be charged.

Introduction of Storage Battery:

Due to the storage battery adopt the advanced free-maintaining technique, customers need not to replenish electrolyte.

The scale should be recharged every 3 months to prevent failure of the internal rechargeable battery.

1. The battery should be charged for 8~10 hours.
2. The temperature of battery should below 45°C.

Maintaining

1. Please do not discharge with over-current when using the battery. Please charge the battery after discharging current.
2. Please take down the battery when the scale is not used for a long time or break the connection of cathode.
3. Do not short the battery terminals to check whether there is current. Please check whether the connection point is firm to guarantee good connection.
4. The battery should be replaced by specialized person. **No reverse-battery or the product will be damaged.**
 - a) Anode of battery should be connected with Anode of product battery (usually red cable)
 - b) Cathode of battery should be connected with Cathode of product battery (usually brown cable or black cable)
 - c) See the picture following

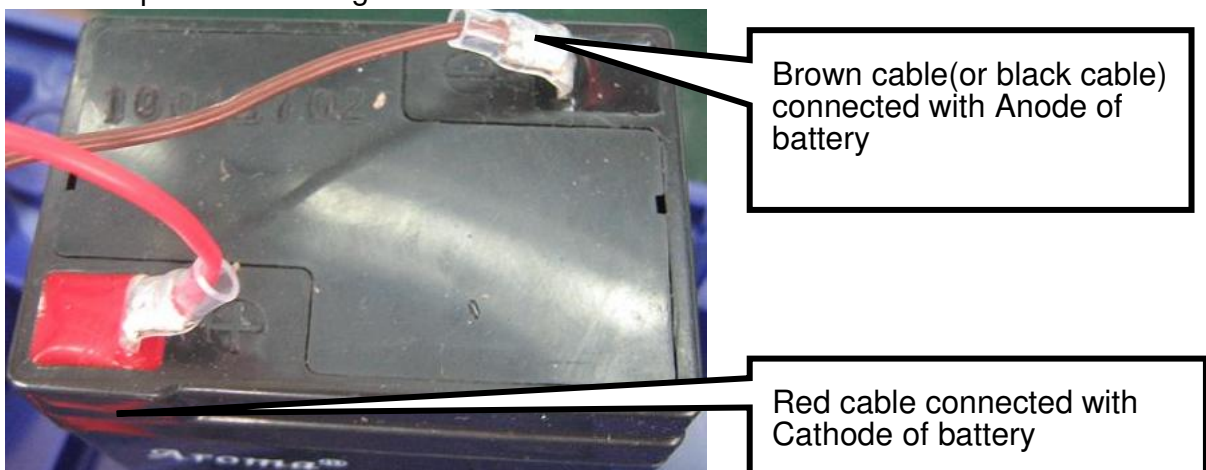

Safety warnings

1. The electrolyte of battery is caustic which causes metal, cotton, etc to corrode.
2. The hydrogen will be resolved when using or charging the battery and it will cause explosion when approaches fire.



No burning



Caution Corrosion



Warning explosion



Children faraway



Chapter 1 Introduction

1-1 Features and Specifications

1. High performance A/D converter
 - 0.3 $\mu\text{V/D}$ high sensitivity
 - Sampling speed 15 times/second
 - non-linear scale 0.01% full scale
 - zero point adjustable range $-2\text{mV} \sim +5\text{mV}$
 - use range $-4\text{mV} \sim +30\text{mV}$
 - load cell stimulate power source 5V DC $\pm 2\%$ 100mA
2. According to different resolution to do linearity calibration
 - Ordinary resolution models (below 10000)
Do specification calibration first then do weight calibration
 - High resolution models (10000~30000)
Do linearity calibration first → specification calibration → weight calibration at last
3. One group of RS232 (option)
4. 5 HOLD functions (contain animal scale HOLD function)
5. LCD display
6. Plug in and rechargeable battery
7. Blackout automatically in order to keep the system stable
(When battery voltage is lower than system voltage, the system will cut the power off automatically to ensure its stable and accuracy.)
8. LED BACKLIGHT

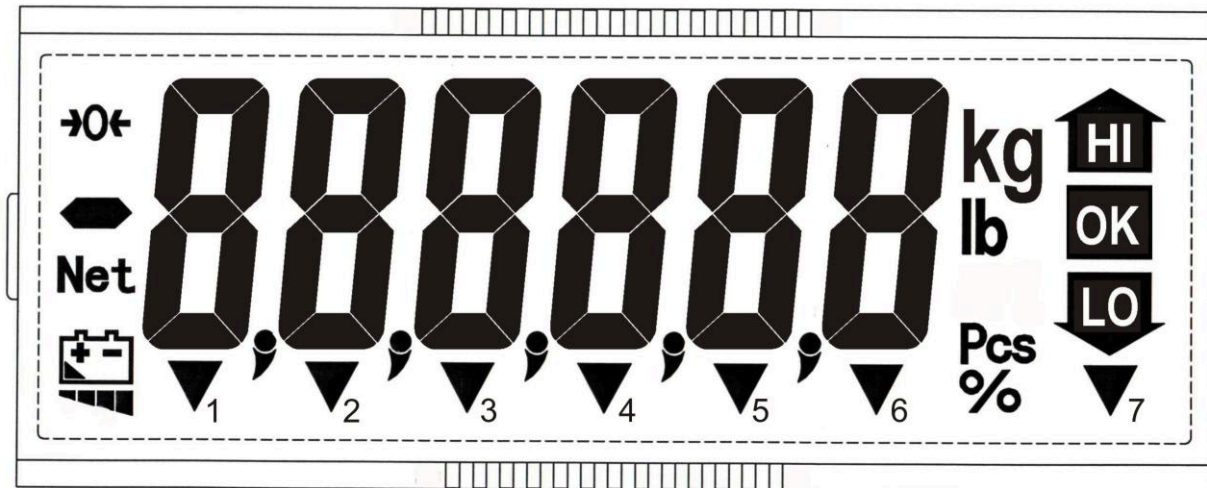
1-2 Display Description



HI	:	High limit value
OK	:	OK value (The value between HI and LO limit value)
LO	:	Low limit value
→0←	:	“Zero” indication
Net	:	“Net weight” indication
	:	“Low battery power” indication
▼1	:	“Stable” indication
▼2	:	“Pre-Tare mode” indication
▼3	:	(M+) “Accumulation mode” indication
▼4	:	No function
▼5	:	 Samples insufficient indication
▼6	:	 Unit weight insufficient indication
▼7	:	“Viss” unit
kg	:	“kg” unit
lb	:	“lb” unit
Pcs	:	Counting mode
%	:	Percent indication













Changes of “Range” indication mode

The indicator with 2-segment specification:

▼6 is Range 1 ▼5 is Range 2

1-3 Keypad Functions Description

10-key model has not  key and  key.

	: Press this key to select the required unit from the preset units.
	: Press this key to preset the weight and quantity.
	: Press this key to accumulate the weight value or others.
	: Press this key to tare (deduct the container weight)
	: Press this key to preset tare value.
	: Press this key to recall the totalizing value, preset value and pre-tare value.
	: Press this key to clear the totalizing value, preset value and pre-tare value.
	: Press this key to zero the scale.
	: Press this key to print the total data and to confirm.
	: Press this key to input the numbers (0 ~ 9) and to light up the backlight.
	: Press this key to go into counting mode.
	: Press this key to sample.

1-4 Power Description

Power Selection

1. 6 V / 4 Ah Rechargeable battery
2. 110 V / 220 V $\pm 15\%$ AC

Recharge Voltage



1. AC 110 V +10% , -15%
2. AC 220 V +10% , -15%

Power Consumption

Indicator + L/C + no backlight	26 mA	180 hours
indicator+ L/C + front display backlight	32 mA	140 hours
Indicator + L/C + front display backlight + back display backlight	40 mA	110 hours
Single RS-232	20 mA	

Low Power Alarm

Please note when the () symbol keeps flashing on the left down corner of the display, the batteries should be recharged.

-  The scale will turn off automatically after a few hours when the low battery warning symbol shows up. The scale must be fully recharged, before operating again.
-  Please recharge at once when the symbol  shows in order to keep the weight accuracy.

1-5 Error Messages

 ⇒ Weight exceeds 9d of maximum capacity. (d=division)

 ⇒ Zero value after power on is over +10% FS.

 ⇒ Zero value after power on is less than -10% FS.

 ⇒ Unstable zero return, unstable over 10 sec. Press  to leave E4.

 ⇒ Zero is too high when calibrating. (above internal value 350,000)

 ⇒ Zero is too low when calibrating. (under internal value 80,000)

----- ⇒ If the negative weight is over 20 divisions and there is no T or PT, the display shows “-----”

Chapter 2 General Operation Description

2-1 Backlight Function

Press  key to select the display backlight mode:

bl. **Auto** ⇒ “Auto Backlight” mode. When the weight is over 10d or any key is pressed, the display backlight will be switched on. When the weight returns to zero (the weight on platform is less than 10d), the display backlight will switch off after 10 seconds.

bl. **on** ⇒ Display backlight is on all the time.

bl. **off** ⇒ Display backlight is off.



2-2 Weighing Mode

2-2-1 Units Selection

1. After indicator is turned on, use  key to select a unit from kg, lb, tael or viss, as the screen indicated.
2. The selected unit will be memorized when you turn the indicator off. And the memorized unit will appear after you turn on the indicator next time.





2-2-2 Check Weighing Mode ⇒ For 12key model

1. Preset “High limit”, “Low limit” and “Beeper value” operation







Use  and  key to preset values.

For example:

Preset “Low limit” (Low limit >10d) e.g. Low limit = 20 kg

Press  key	the display shows	≥ 0 ≤ - - . - - L
Press  key 1 time	the display shows	0 ≥ 0 ≤ - . - - L
Press  key 2 times	the display shows	0 ≥ 2 ≤ - . - - L
Press  key 4 times	the display shows	0 2 0.00 ≥ 0 ≤

Preset “High limit” (High limit ≥ Low limit) e.g. High limit = 25 kg

Press  key 1 time	the display shows	≥ 0 ≤ - - . - - H
Press  key 1 time	the display shows	0 ≥ 0 ≤ - . - - H
Press  key 2 times	the display shows	0 ≥ 2 ≤ - . - - H
Press  key 1 time	the display shows	0 2 ≥ 0 ≤ . - - H
Press  key 5 times	the display shows	0 2 ≥ 5 ≤ . - - H
Press  key 3 times	the display shows	0 2 5.00 ≥ 0 ≤

Preset “Beeper value” (Refer to Note) e.g. Beeper value = 22

Press	key 1 time	the display shows	$\geq 0 \leq - b$
Press	key 2 times	the display shows	$\geq 2 \leq - b$
Press	key 1 time	the display shows	$2 \geq 0 \leq b$
Press	key 2 times	the display shows	$2 \geq 2 \leq b$
Press	key 1 times	the display shows	0.000

☰ Preset Single point (preset low limit only):

After “preset low limit” procedures is completed and the display shows $\geq 0 \leq - - - - H$, press key again, the display shows 0.000. This means that the “preset single point” procedure is completed.

NOTE

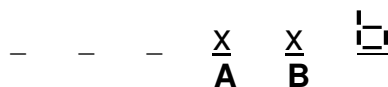

- A** Setting for the status that LCD is on and the beeper beep:
- 0 = when stable, the beeper beeps and LCD is on.
 - 1 = when stable, the beeper beeps; whether stable or not, LCD is on.
 - 2 = whether stable or not, the beeper beeps and LCD is on.
 - 3 = open warning device: when the weight is higher than HI value and the weight is stable, LCD is on and Relay Card open.

- B** Setting for the beep status:
- 0 = No beep
 - 1 = OK (when the weight is over Low Limit & under or equal to High Limit.), the beeper beeps.
 - 2 = When the weight is under or equal to Low Limit & over High Limit, the beeper beeps.

☰ Under Status in Preset Low Limit (preset single point only)

The BEEP, LCD mode should be fixed as follows:

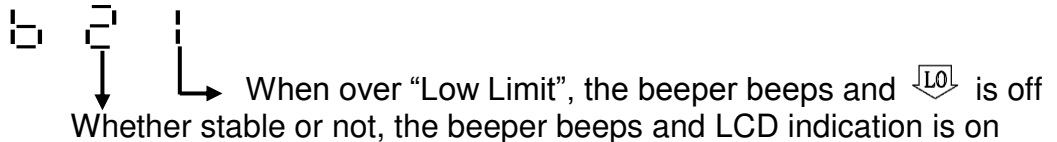

☰ Warning device setting

Set HI value and value of the beep, LCD mode should be fixed as follows:

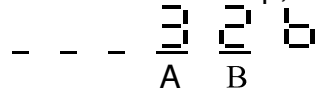

When the weight equals to HI value, Relay Card open and the weight is accumulated.

Press key to dismiss the warning sound and the range of accumulated weight is [000.000]~[999999].

☰ Clear warning accumulation

- ◆ Press key first and then press key to clear all accumulated data.
- ◆ Accumulated data is cleared automatically under in following conditions
 - a. when shift among weight mode, counting mode and warning accumulation mode.
 - b. when shift the units

c. turn off the scale

 LCD indication:

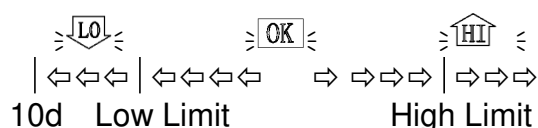



◆ To exit preset mode, press  key.

2. Recall Check-weighing Values



Press  key then press  key ⇒ Recall “Low limit value”

Then press  key again ⇒ Recall “High limit value”



Then press  key again ⇒ Recall “Beeper value”

Then press  key again ⇒ Back to the beginning

3. Clearing Check-weighing Values

Press  key then press  key, then press  key ⇒ Recall “Low limit value”

Then press  key again ⇒ Clear “High limit value” and “Beeper value”

Press  key; then press  key 6 times continuously ⇒ Clear all values.



2-2-3 Totalizing

1. Weight Totalizing

Place goods on the platter, after stable and press  key to save the weight value.

Then the display shows the total number of additions and the totalized weight value.

The (M+) indication “▼” will flash on the display. The indicator will recover to show the weight value of the goods on the platter after 3 seconds; the (M+) indication “▼” is on.



 The indicator allows the next totalizing operation, even when the weight value does not return back to zero. The  key is functional, when the weight value changes by more than 10d. The indicator will save the totalized weight value after the weight is stable.

 The indicator can totalize positive or negative weight but can't do both at the same time. The totalized weight store must be reset to zero before it is possible to select positive or negative totalizing mode.

 The totalizing function can be used up to a maximum of 9999 times before it must be reset. The totalizing display is limited to 6 digits maximum.

 When totalizing, RS-232 will also output. (Refer to F5 setting)

2. Clear Totalized Weight Values

- ◆ Press  then  key to clear all totalized weight values.
- ◆ When changing between weighing and counting mode, or selecting weighing unit, the indicator will automatically clear all the totalized weight values.
- ◆ The indicators will automatically clear all the totalized weight values after turning on.

3. Recall Totalized Weight Values

Press  key to display the total number of additions and the totalized weight value.

And the (M+) indication “▼” will flash on the display. The indicator will return to the weighing mode after 3 seconds.



The indicator will not display the negative sign “-” for negative totalized weight values when recalling a totalized weight value, but when printing, the negative sign “-” will be printed out (transmitted serially) for each negative weight and negative totalized weight.

2-2-4 Zero Function

Press  key to re-zero the display with no load on the platter. When zero is set, the (→0←) symbol will be displayed.



2-2-5 Tare Function

1. When the weight of the container is unknown.

- ❶ Place the container on the platter, after stable and press  key, the weight value returns to zero and net indication (**Net**) is on.
- ❷ Place goods into the container; the display shows the net weight of goods.
- ❸ Clear tare value

When removing the container and goods, the display shows the negative weight value of the container. Press  key to clear tare value. The indicator returns to zero and net indication (**Net**) is off.

- ❹ Recall tare value

Press  then  key ⇒ the display shows tare value





Multiple tare operation ⇒ Users can continuously increase or decrease the tare value by pressing the  key.



The total tare value (tare value + pre-set tare value) can max. equal the full capacity of the scale



2. When the weight of the container is known.

① Press  key; the display shows $\geq 0 \leq - - . - - P$.



Use  and  keys to input weight value of the container. After finishing the procedures, the Net indication and PreTare (PT) indication (“▼”) are active.

② Place the goods into the container. The indicator shows the net weight of goods.

③ Clear PreTare value.

Press  then  key, and then press  key to clear pretare value. When the display returns to zero, net indication and Pretare indication “▼” are off.

④ Recall PreTare value.

Press  then  key \Rightarrow the display shows Pretare value

 In Tare mode, the PreTare function is disabled.

 The indicators with two weighing ranges can NOT pre-set the tare value larger than the first weighing range. For example: a 30 kg indicator is set by two weighing ranges. The first range is 0 to 15 kg, and the second range is 15 to 30 kg. The pre-set tare value can not be larger than 15 kg.

2-3 Counting Function

1. Press  key to select sample quantity from 10, 20, 50, 100 the display shows 10 or 20 or 50 or 100 accordingly.

2. Place the selected sample quantity on the platter

press  key; the display shows SAMPLE .

After STABLE is active, the scale enters into counting mode and the display shows the sample quantity.

3. Place the parts on the platter; the display shows the number of pieces (Pcs)

◆ Sample quantity too small (less than 20d); indicator at 

◆ Unit weight too small (less than 0.2d); indicator at 

 If one or two of the symbols are active, the scale can still work, but the counting accuracy is limited.

 When using 2-segment weighing mode, the above two symbol indications change to Range 2 and Range 1 and the two symbol indications are off.

Chapter 3 General Function Setting

- ◆ Switch on the scale. While the scale is counting down to zero, press and hold key until the display shows the software program version number **020 18**. Release the key, the scale enters into the configuration setting mode and **F 0** is showed on the display.

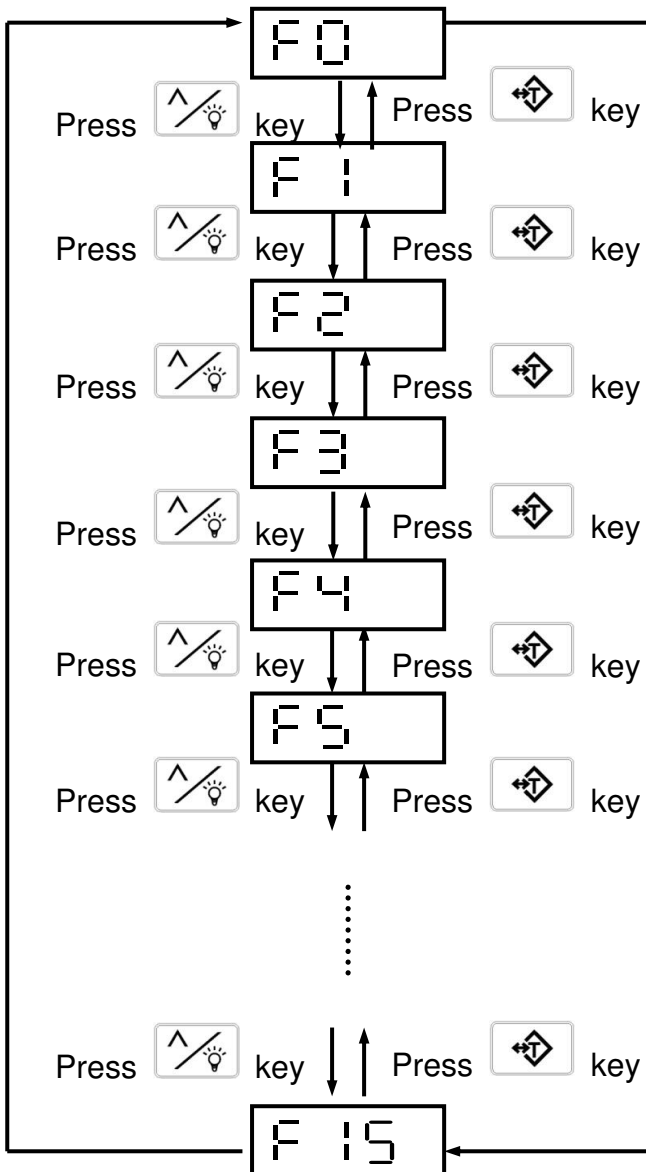

- F 0 ⇒ Reserved
- F 1 ⇒ Reserved
- F 2 ⇒ Reserved
- F 3 ⇒ Reserved
- F 4 ⇒ Check-weighing configurations
- F 5 ⇒ RS-232 Interface output Setting
- F 6 ⇒ Exit setting mode
- F 7 ⇒ Internal value display mode
- F 8 ⇒ Reserved
- F 9 ⇒ Reserved
- F 10 ⇒ G Value adjustment
- F 11 ⇒ ID code setting
- F 12 ⇒ Print key () function setting
- F 13 ⇒ Reserved
- F 14 ⇒ Printing orders when F 5 is set as **r n P 6** or **r n P 7**
- F 15 ⇒ Reserved

3-1 F4 ⇒ Check Weighing Configurations

◆ If F8 is set, accessing to F4 is denied.

Use or key to select F4 function ⇒ the display shows F4

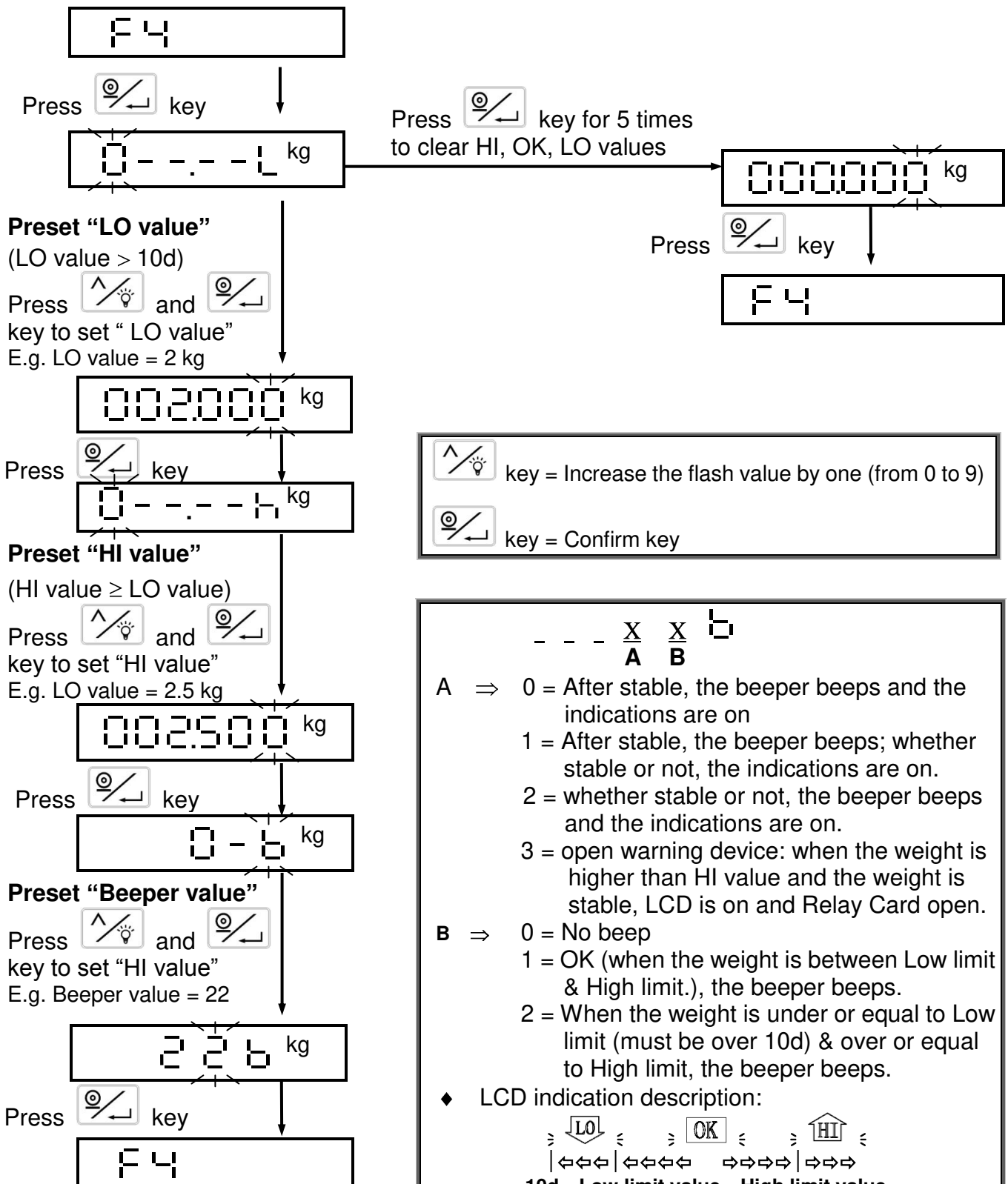

key = Increase the flash value by one (from 0 to 9)
 key = Confirm key

- - - X X b
 A B



A ⇒ 0 = After stable, the beeper beeps and the indications are on
1 = After stable, the beeper beeps; whether stable or not, the indications are on.
2 = whether stable or not, the beeper beeps and the indications are on.
3 = open warning device: when the weight is higher than HI value and the weight is stable, LCD is on and Relay Card open.

B ⇒ 0 = No beep
1 = OK (when the weight is between Low limit & High limit.), the beeper beeps.
2 = When the weight is under or equal to Low limit (must be over 10d) & over or equal to High limit, the beeper beeps.

◆ LCD indication description:

10d Low limit value High limit value

3-2 F5 ⇒ RS-232 Interface Output Setting (option)

Use  or  key to select F5 function ⇒ the display shows F5

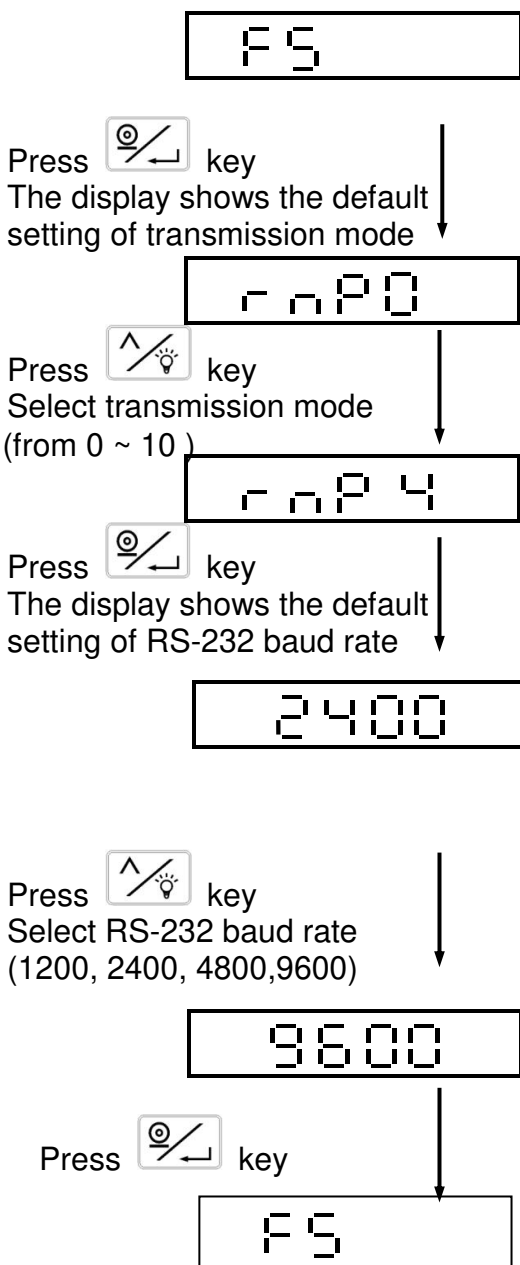

 key = Increase the flash value by one (from 0 to 10) or selecting baud rate from 1200, 2400,4800 and 9600(default setting).

 key = Confirm key

r n P 0 ⇒ No transmission (RS-232 closed)

r n P 1 ⇒ Stable transmission *

r n P 2 ⇒ Continuous transmission *

r n P 3 ⇒ Press  key to transmit in simple mode. *

r n P 4 ⇒ Press  key to transmit in complete mode. *

r n P 5 ⇒ Stable transmission in totalizing mode.
The format is as same as r n P 3 *



r n P 6 ⇒ Refer to F14 *

r n P 7 ⇒ Refer to F14 *

r n P 8 ⇒ Press  key to transmit. *

The format is as same as r n P 1 and r n P 2. *

r n P 9 ⇒ Continuous transmission , specific format *

r n P 10 ⇒  or  transmit specific format*

* : RS-232 is open

RS-232 Interface Format

I . Mode: UART Signal of EIA-RS0232 C

II . Format :

1. Baud rate : 1 200, 2 400, 4 800, 9 600 bits/second
2. Data bits : 8 bits
3. Parity bit : None
4. Stop bits : 1 bit
5. Code : ASCII (Exchange code of American standard)

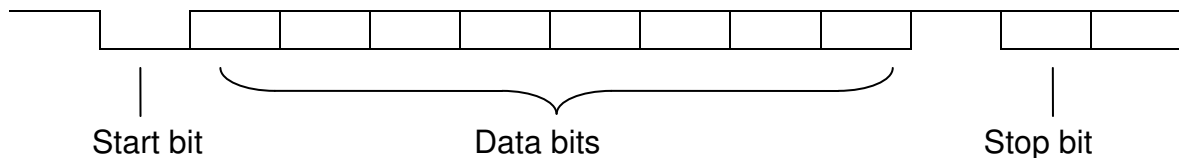

RS-232 Data Format

Stable transmission ($\overline{\text{RNP}} \text{ I}$), Continuous transmission ($\overline{\text{RNP}} \text{ E}$),
 Press  key to transmit ($\overline{\text{RNP}} \text{ 8}$)

9. gram as weight unit

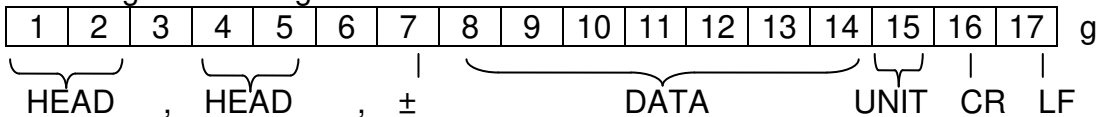

10. kg or lb as weight unit

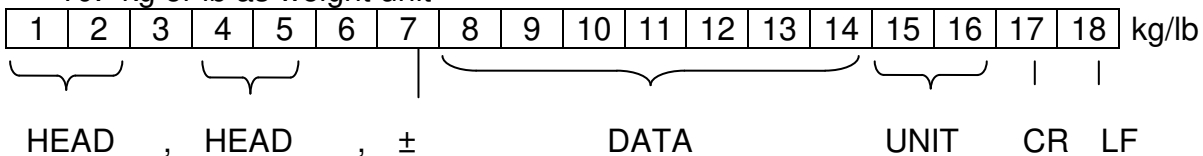

11. lb.oz as weight unit

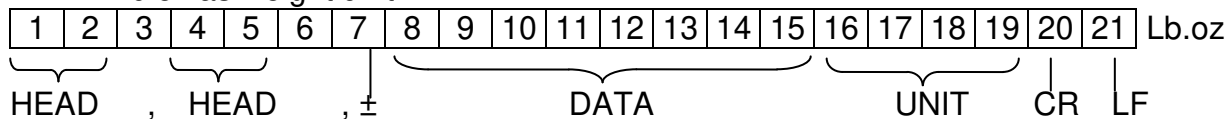

12. HK tael as weight unit

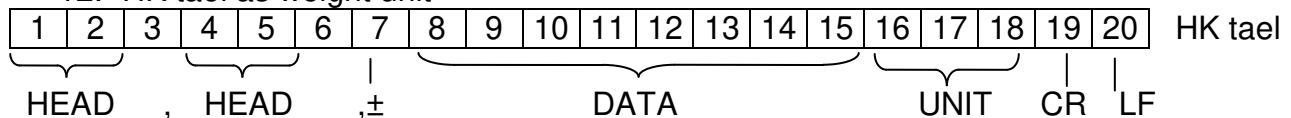

13. viss as weight unit

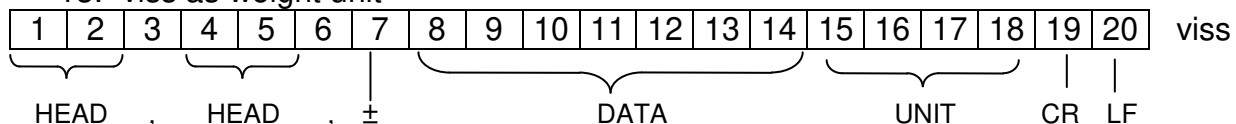

HEAD1 (2 BYTES)				HEAD2 (2 BYTES)			
OL	-	Overload	,	Under load	TR	-	TARE Mode
ST	-	Display is Stable		NT	-	NET Mode	
US	-	Display is Unstable		GS	-	GROSS Mode	

DATA (7 or 8 BYTE)

2B (HEX) = “ + ” (PLUS)

2D (HEX) = “ - ” (MINUS)

2E (HEX) = “ . ” (DECIMAL POINT)

UNIT (2、 3 or 4 BYTE)

kg = 6B (HEX) ; 67 (HEX)

lb = 6C (HEX) ; 62 (HEX)

tl.T = 74 (HEX) ; 6C (HEX) ; 2E (HEX) ; 54 (HEX)

hkg = 68 (HEX) ; 67 (HEX)

viss = 76 (HEX) ; 69 (HEX) ; 73 (HEX) ; 73 (HEX)

Transmission examples:

Data format for RS-232 continuous transmission are as below:

1. The gross weight (+0.876 kg) shows as below, after stable: (no tare or pre-tare mode)

S	T	,	G	S	,	+			0	.	8	7	6	k	g	0D	0A
HEAD1			HEAD2			DATA								UNIT	C	LF	

2. The net weight (-1.568 lb) shows as below without weight stability: (tare or pre-tare mode)

U	S	,	N	T	,	-			1	.	5	6	8	l	b	0D	0A
HEAD1			HEAD2			DATA								UNIT	C	LF	

3. The net weight (+15.0624 HK tael) shows as below, after stable: (tare or pre-tare mode)

S	T	,	N	T	,	+	1	5	.	0	6	.	2	4	h	k	g	0D	0A
HEAD1			HEAD2			DATA								UNIT	C	LF			

4. The net weight (+1.245 viss) shows as below, after stable: (tare or pre-tare mode)

S	T	,	T	R	,	+			1	.	2	4	5	v	i	s	s	0D	0A
HEAD1			HEAD2			DATA								UNIT	C	LF			

Press  key to transmit (simple mode)    

S/N WT/UNIT (kg / lb)

0001 1.0000

→ Press  or  key

0002 1.0000

→ Press  or  key

0003 1.0000

→ Press  or  key

0004 1.0000

→ Press  or  key

0005 1.0000

→ Press  or  key

0005 5.0000

→ Press  twice to print TOTAL

Press  key to transmit (complete mode)    

TICKET NO. 0001
G 1.000kg
T 0.000kg
N 1.000kg

→ Press  or  key

(3 blank lines)

TICKET NO. 0002
G 1.000kg
T 0.000kg
N 1.000kg

→ Press  or  key

(3 blank lines)

TICKET NO. 0003
G 1.000kg
T 0.000kg
N 1.000kg

→ Press  or  key

(3 blank lines)

TOTAL NUMBER
OF TICKETS 0003
TOTAL
NET 3.000kg

→ Press  twice to print TOTAL

(3 blank lines)

 G = GROSS T = TARE PT = PRE-TARE N = NET

Stable Transmission (totalizing mode)

S/N	WT/UNIT (kg / lb)	
0001	1.0000	→ The scale is stable
0002	1.0000	→ The scale is stable
0003	1.0000	→ The scale is stable
0004	1.0000	→ The scale is stable
0005	1.0000	→ The scale is stable
0005	5.0000	→ Press  twice to print TOTAL

RS232 output format in HOLD MODE

Please set    in  .

If there is only RS-232, press  to print out the HOLD value on the display.

Continuous Transmission (specific form) (Brazil customer)

The print out is as below:

If display shows 70.15kg, the RS-232 export is 51.07000

If display shows -70.15kg, the RS-232 export is 51.0700-

If display shows OL, then RS-232 print nothing.

Press  or  key transmit (specific form)     

 Print out format

F	R	"	W	T	3	N	"	<LF>										
?	<LF>																	
G	G	,	G	G	G	<LF>												
T	T	,	T	T	T	<LF>												
PT	PT	,	PT	PT	PT	<LF>												
N	N	,	N	N	N	<LF>												
pcs	pcs	pcs	pcs	pcs	pcs	<LF>												
n	n	n	n	n	n	t	t	t	t	t	pcs	pcs	pcs	pcs	pcs	pcs	<LF>	
p	1	,	1	<LF>														

For example:

PT 0.3KG

T 0.7KG

G 1.2KG

N 0.2KG

PCS 20

Then the printing form is:

FR"WT3N "

?

1,200

0,700

0,300

0,200

20

000020001000000020

P1,1

Use  +  key or  key twice to clear the format

Then, form of clearing the printing:

F	R	"	5	2	0	T	"	<LF>												
?	<LF>																			
TN	TN	TN	TN	TN	TN	<LF>														
TW	TW	TW	TW	TW	TW	<LF>														
TA	TA	TA	TA	TA	TA	<LF>														
tn	tn	tn	tn	tn	tn	<LF>														
tn	tn	tn	tn	tn	tn	tw	tw	tw	tw	tw	tw	tw	ta	ta	ta	ta	ta	ta	<LF>	
p	1	,	1	<LF>																

FR"520T "

?

1

0,200

20

000001000200000020



P1,1

3-3 F 6 ⇒ Exit Function Setting Mode

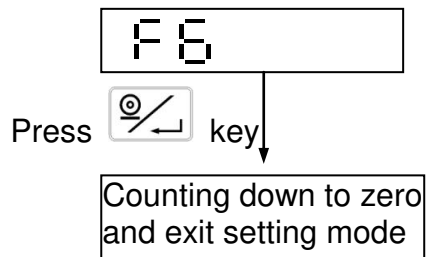
Use  or  key to select F6 function ⇒ the display shows F 6



3-4 F 7 ⇒ Internal Value Display Mode

Use  or  key to select F7 function ⇒ the display shows F 7

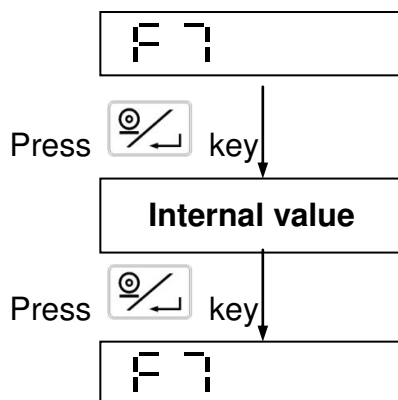

3-5 F10 ⇒ G value Calibration

Use key or key to select F10 function. ⇒ The display shows F10.

You can input at most 9 sets of G value's data. The historic data is displayed but can not to be revised.

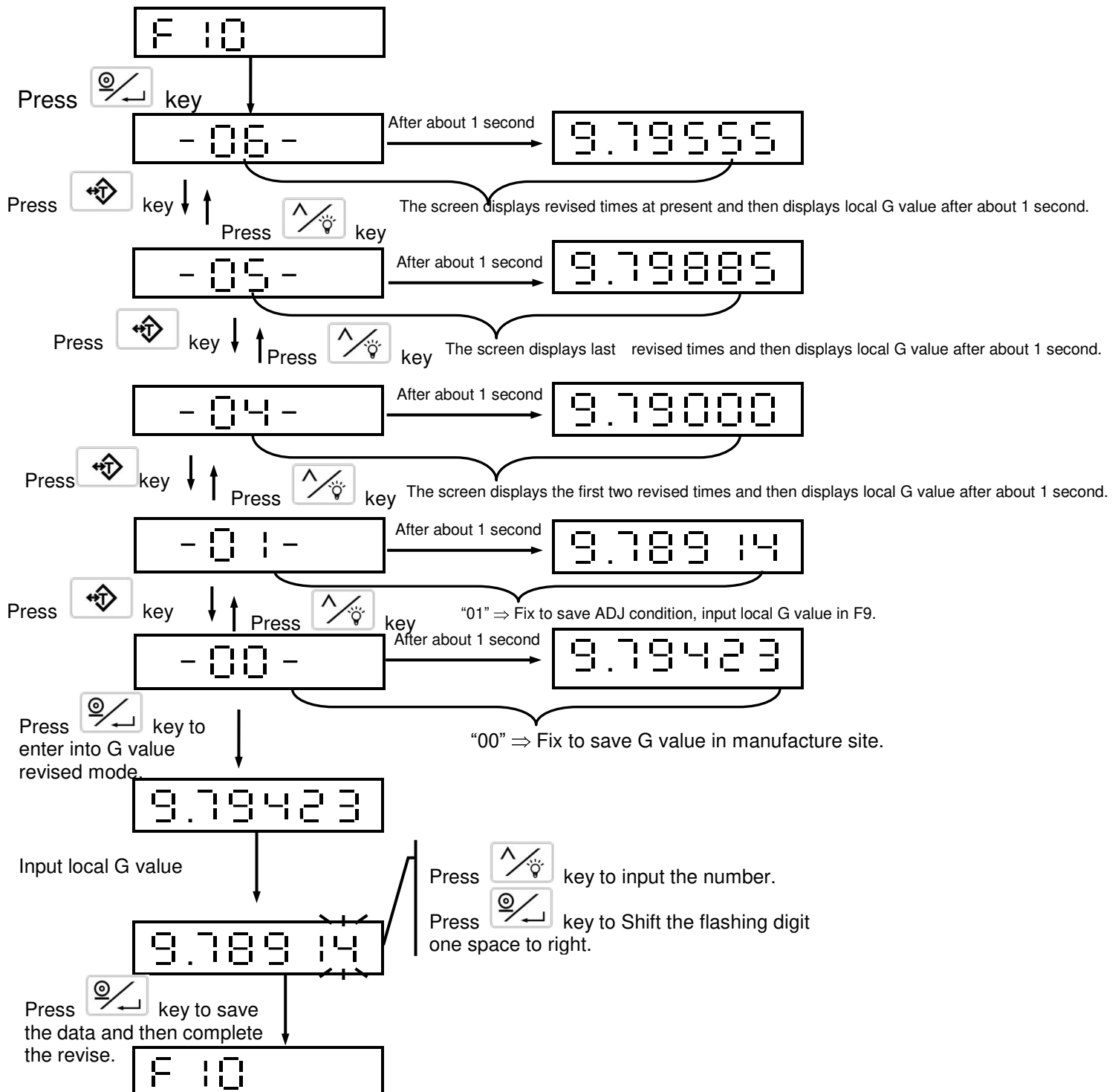

3-6 F I I ⇒ ID Code Setting

(Use must be in coordination with F 5 r n P 1 , 2 , 8)

Use key or key to select F11 function ⇒ the display shows F I I

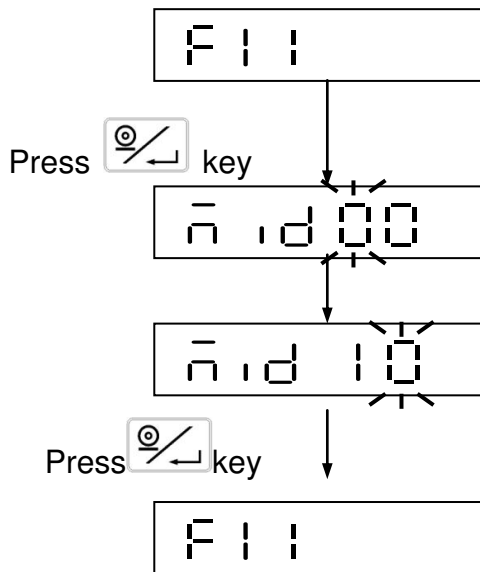

Machine ID code setting:
 Press and to set 01 ~ 99
 Default setting: 00
 (1) "00": RS-232 does not transmit Machine ID
 (2) "01~99": RS-232 transmits Machine ID

RS232 Data format

Stable transmission (r n P i), Continuous transmission (r n P e),
 Press key to transmit (r n P 8)

1. e.g. Machine ID code is 10.

The gross weight (+0.876 kg) shows as below, after stable: (no tare or under pre-tare mode)

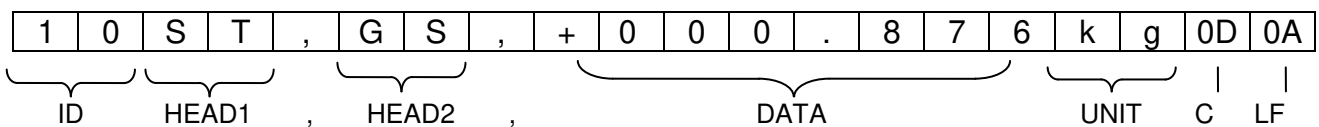

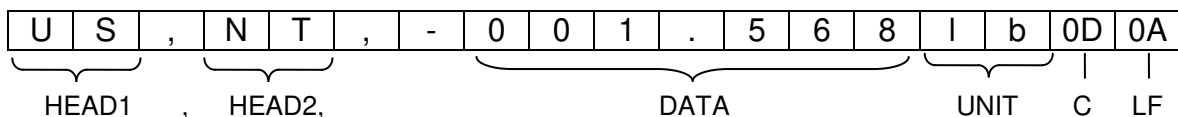

2. e.g. Machine ID code is 00. (Not using Machine ID function.)

The net weight (-1.568 lb) shows as below without weight stability: (under tare or pre-tare mode)



3-7 F12 ⇒ Print Key () Function Setting

Use  key or  key to select F12 function ⇒ the display shows F12

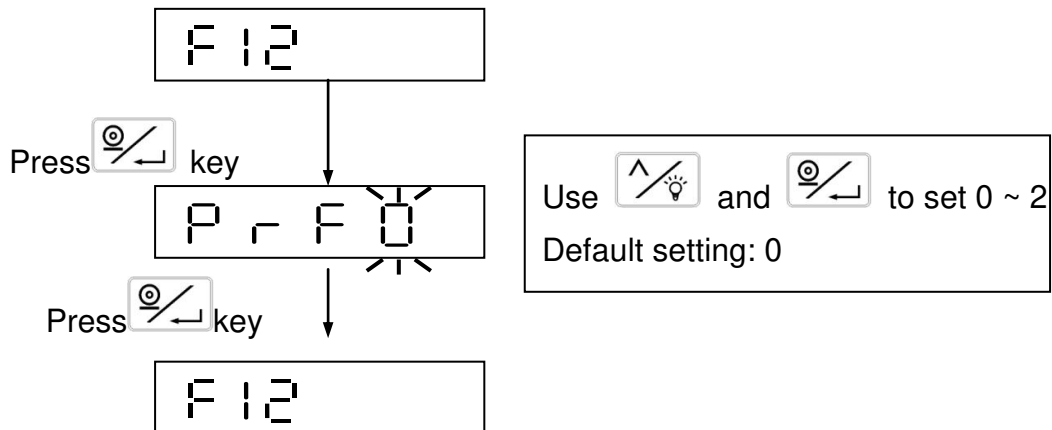

PrF 0 ⇒ Press  key to print current weight if weight variation is within $\pm 1d \sim \pm 10d$, or to print accumulated weight if weight variation is over $\pm 10d$. (d=division)

PrF 1 ⇒ Press  key to print the current weight at once. (no totalization)

PrF 2 ⇒ Press  key to print the current weight if it is within the lower and upper limits. (no totalization)

3-8 F 14 ⇒ Printing orders when F 5 is set as r n P 6 or r n P 7

No.0	No print.
No.1	TICKET NO.
No.2	G
No.3	T
No.4	PT
No.5	N
No.6	P/N
No.7	S/N
No.8	No print
No.9	No print



F 14 Contains a 9-digit code

If F 14 is set as 8900000000



❶ The format of r n P 6 is as following

S/N WT/UNIT (kg / lb)



0001 1.0000

→ Press  key or Press  key



0002 1.0000

→ Press  key or Press  key



0003 1.0000

→ Press  key or Press  key

0004 1.0000

→ Press  key or Press  key

0005 1.0000

→ Press  key or Press  key

0005 5.0000











→ Press  key twice to print the total

❷ The format of r n P 7 : RS-232 print nothing

If F14 is set as 896 123 450

① The format of \overline{r} \overline{n} \overline{P} \overline{E} is as following

P/N 012345678901
 TICKET NO. 0001
 G 75.01kg
 T 0.00kg
 PT 0.00kg
 N 75.01kg
 S/N WT/UNIT (kg / lb)

0001	1.0000	→ Press  key or Press  key
0002	1.0000	→ Press  key or Press  key
0003	1.0000	→ Press  key or Press  key
0004	1.0000	→ Press  key or Press  key
0005	1.0000	→ Press  key or Press  key

0005	5.0000	→ Press  key twice to print the total.

② The format of \overline{r} \overline{n} \overline{P} \overline{I} is as following











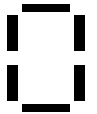
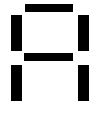



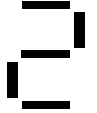
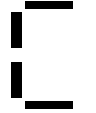
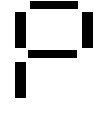
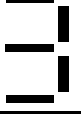
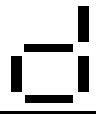
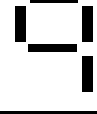
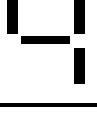
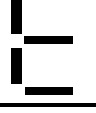

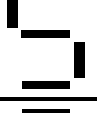
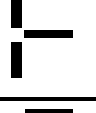

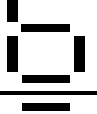
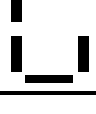
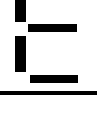

P/N 012345678901
 TICKET NO. 0001
 G 75.01kg
 T 0.00kg
 PT 0.00kg
 N 75.01kg

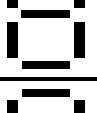
→ Press  or  key

TOTAL NUMBER
 OF TICKETS 0001
 TOTAL
 NET 0.499kg

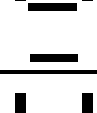
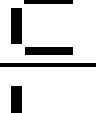
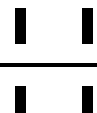
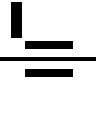
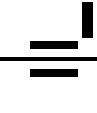
→ Press  key twice to print the total

Appendix 1 7-Segment Display Characters

Number	Display	Letter	Display	Letter	Display
0		A		N	
1		B		O	
2		C		P	
3		D		Q	
4		E		R	
5		F		S	
6		G		T	
7		H		U	
8		I		V	
9		J		W	
		K		X	
		L		Y	
°C		M		Z	



Energieweg 47 | Oosterhout | 4906 CG
T +31 (0) 0168 357755 | F +31 (0) 168 380227
E info@dkmtools.nl | W www.dkmtools.nl