

Digital force gauge DSV/DST series

- Ideal for hand-held use due to the hand fitting design and the lightweight
- Easy data management and OK judgement
- In capacity up to 1000N, handling a wide range of force testing

DSV improves reproducibility in hand-held use.

DSV is an advanced model equipped with tilt-sensing function, Internal memory (1000) function, and more.



DST has excellent cost-performance.

You can use it for both tension and compression. You can switch real-time measurement and peak-hold measurement. It equips OK judgement or reversible indication functions for greater usability.



Newly added functions to improve work efficiency

DSV sounds alarms when you tilt it to right/left or up/down from the preset position, for greater accuracy.

Beep sound



- DSV has tilt-sensing function, sounding alarms when it senses a tilt from the pre-set position.
- When it sounds an alarm, "NG" is recorded.
- * DST does NOT have the tilt-sensing function.

You can connect maximum 4 pcs of DSV/DST to PC at the same time, for easier management.



- You can record acquired data, date, OK judgement.
- * You need a dedicated optional software for this.

You can prevent DSV/DST from sensor-breakdown due to mechanical stopper.



- DSV/DST-2N/5N/20N/50N has mechanical stopper for overload preventing.
- * You cannot prevent overload in some cases.

DSV/DST has longer battery life and great portability.

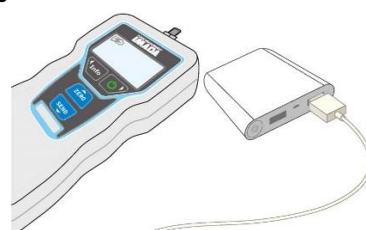

- Battery life lasts 30 hours at maximum when its backlight is off.
- You can charge it from a PC or a mobile battery.

[Main functions]

◎Indicate force digitally

Digital indication offers NO individual differences in reading.

◎Reversible indication

The indication can be turned upside down as desired with simple button operation.



◎OK judgement

You can set upper/lower limit, then, it indicates OK.

◎Display

Time, battery life, and other information can be indicated as desired. It can indicate the last values, or peak & real time values at the same time.



◎Calibration schedule reminder

You can set up the desired date for next calibration, then on 30 days before the set date, it reminds you of the next calibration by a message on its monitor.

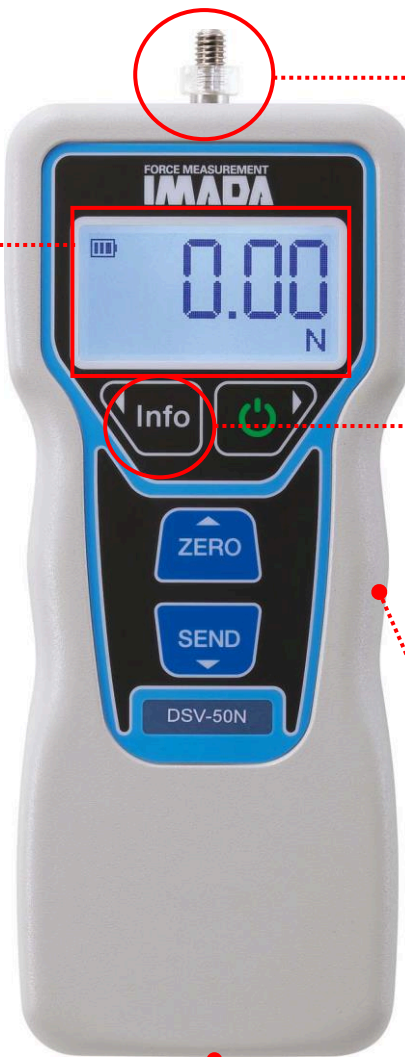

◎You can easily attach an attachment.

Thread is M6 screws, and IMADA attachments are designed to fit into the thread. A plastic nut is supplied to adjust attachment's position.

◎Settings

You can set up about peak capturing mode, upper/lower limit, operation sound, etc.



◎Languages

◎Hand fitting design

You can apply force stably due to easy-gripping shape and durable aluminum die-casting body.

◎Connector for USB & RS232C

It equips connectors for USB cable and RS232C.

You can charge it from a PC or a mobile battery using a supplied USB cable.



[Other functions]

DSV & DST	DSV only
Sensitivity Sign inversion Setting lock Off timer (auto power-off) Overload alarm	Tilt-sensing alarm Continuity peak mode Internal memory (1000 points)

[6 supplied attachments]

DSV and DST come with the 6 attachments below. You can perform simple compression / tension test using the attachments.

Small hook A-1(S-1 *1)	Flat tip A-2(S-2)	Conical tip A-3(S-3)	Chisel tip A-4(S-4)	Notched tip A-5(S-5)	Extension shaft A-6(S-6)

* DSV(DST)-2N/5N/20N/50N come with aluminum attachments(A-type). DSV(DST)-200N/500N/1000N come with steel made

[DS specifications]

Model	DSV	DST
Accuracy	±0.2%F.S.(full scale)±1digit	
Unit	N(mN, kN), kgf(gf), lbf (*1)	
Display	4-digit LCD	
Sampling rate	Max. 1000 data/sec	
Battery	Approx.30 hours (when back light is off) Approx.14 hours (when back light is on) (need 4.5 hours for full charge)	
Overload	Approx.200%F.S.	
Power	Nickel-Metal Hydride battery (NiMH battery) , USB charge(PC, mobile battery, AC adapter)	
Operating environment	Temperature : 0 - 40°C, Humidity : 20 -80%RH	
Functions	Peak hold(Tensile or compression)/Comparator(OK Judgement)/Sensitivity(3 steps)/ Reversible display /Sign inversion/Setting lock/Date & Time/Off timer (Auto power-off)/ Reminder for calibration schedule/Overload alarm	
	Tilt-sensing alarm/Continuity peak mode(*2) /Internal memory (1000 point)	
Output	USB/RS232C	
Overload alarm	Alarm to notify "near-overload state": Approx. 90%F.S. (Alarm sound) Alarm to notify "overloaded state" : Approx.110%F.S. (Alarm sound/ Indication blinking)	
Weight	Approx.460g (*3)	
Dimensions	Refer to Dimensions on page 5.	
Accessories	CD driver (including data logging software)/USB cable/AC adaptor/ Attachments (The types of attachments vary by models)/Carrying case/ Instruction manual/Inspection certificate	

*1 These are the specifications for International model. Note that the available units are different from Japanese domestic model and international one. kN is available at 1000N, mN and gf is available at 2N and 5N ranges.

*2 You cannot use Continuous peak mode when the measurement does not reach 10% of the force gauge's capacity. Instead, use Peak mode. Continuous peak mode could not fit enough for measurement with a shock such as break tests. Contact us for further details.

*3 The weights are slightly different by the model.

[DS models]

Model	Capacity	Display	Resolution	Measuring shaft	Included nut
DSV(DST)-2N	2N	2.000N	0.001N	M6 P1.0 (Coarse thread) Thread length: 11.6mm	Hexagon nut Material: Resin Height: 5mm
DSV(DST)-5N	5N	5.000N	0.001N		
DSV(DST)-20N	20N	20.00N	0.01N		
DSV(DST)-50N	50N	50.00N	0.01N		
DSV(DST)-200N	200N	200.0N	0.1N		
DSV(DST)-500N	500N	500.0N	0.1N		
DSV(DST)-1000N	1000N	1000N	1N		

※DSV(DST)-1000N come with SR-1, DSV(DST)-200N/500N come with S-1.

[Supplied Software : Force Logger]

Using a supplied USB cable, you can easily transfer data form DSV(DST) to PC.

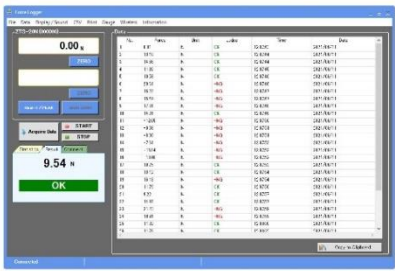
	<p>Features</p> <ul style="list-style-type: none"> - Data transfer to PC at 10Hz with ease. - Displaying various measuring data such as Maximum, Minimum, and Average values - Data recording in CSV format. - Setup function of the force gauge's setting. <p>Operating environment</p> <ul style="list-style-type: none"> - OS: 8.1/10/11 - Hardware: 1GHz or more, Memory: 2GB or more recommended, Hard disk: 10GB or more recommended - Platform: .NET Framework4.8 or later - Image size: Resolution 1024*768 pixel more
----------------------------------------------------------------------------------	----------------------------------------------------------------------------------------------------------------------------------------------------------------------------------------------------------------------------------------------------------------------------------------------------------------------------------------------------------------------------------------------------------------------------------------------------------------------------------------------------------------------------------------------------------------------------------------------------------------------------------

Advanced

You can combine DSV(DST) with a test stand and software to

Improve accuracy & efficiency in measuring & data management

- You can apply load straight, reducing fluctuation.
- Test stands apply high-capacity force such as 100kgf.
- Using a graphing software, you can see force transition visually.

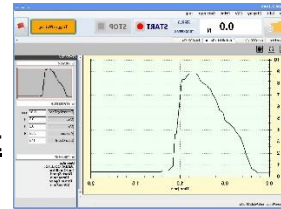

Graphing software ZLINK4-E↑

Manual test stand SVL-100



[Related Products]

Graphing software : ZLINK4

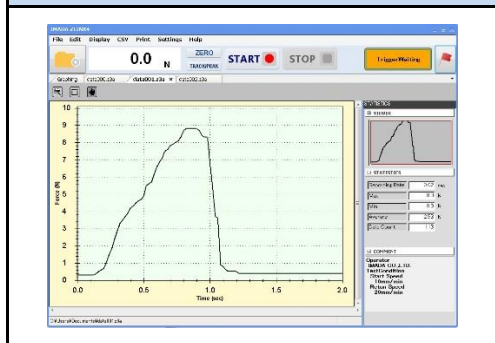

Main features of ZLINK4

- You can draw a graph of force-time at 50Hz.
- You can determine time period for recording in trigger (auto start) function.
- You can save data in CSV format.
- You can connect DSV/DST to PC using the supplied USB cable.

* See the specification of ZLINK4 for further information.

Software to manage 4 pcs of gauges : Force Logger Plus

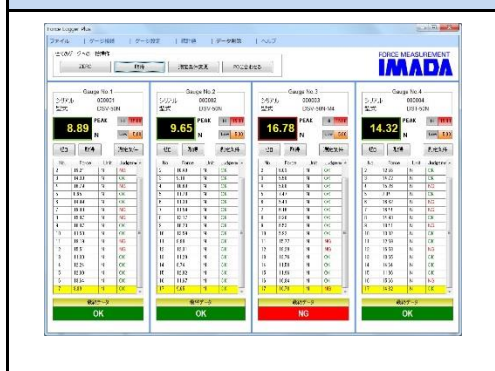

Main features of Force Logger Plus

- You can connect Max. 4 pcs of force gauges and receive data from them.
- Using the supplied USB hub, you can easily connect 4 pcs of force gauges.
- Each data individually shows test date & time, one in charge, by a serial No. of a force gauge.
- You can save data in CSV format.

* Please ask us for the detail of the software.

Digital force gauges ZTS/ZTA series



Main features of ZTS/ZTA

1. ZTS/ZTA improves the reproducibility of measurement due to its high sampling rate (2000Hz).
2. Clear organic display, 8 language availability, and more useful functions
3. You can visually see small changes in force using an optional graphing software.
4. You can combine ZTS/ZTA with a motorized test stand or other equipment due to its output functions.
5. ZTA can input/output displacement.

* See the specifications of ZTS/ZTA for further information.

Handle : FOH-1 RS232C cable (9P) : CB-203 Replacement battery : BP-403



Combining a force gauge with this handle by screws, you can apply force stably.



The cable connects a PC to a force gauge, enabling to transmit command signals.



You can open the battery cover of DSV/DST, and replace it very easily.

[Dimensions]

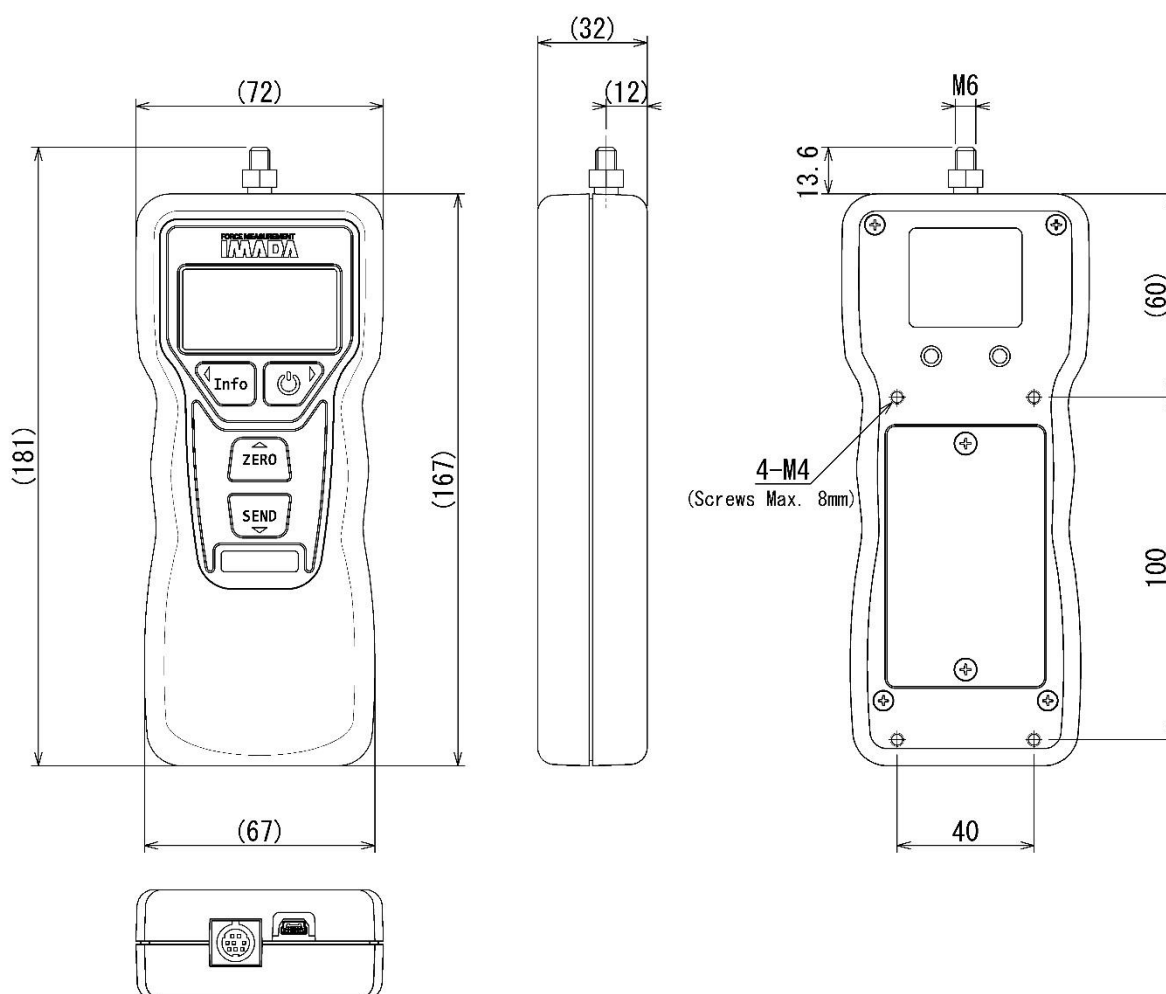

Unit: mm

[Calibration certificate & ISO 17025 calibration services]

As an option, we offer calibration certificates and traceability charts with extra charges.

Moreover, we can offer calibration services according to ISO/IEC17025: 2005. Contact us for details.

[Cautions]

- The contents may be changed without previous notice.
- All of products are designed for measurement purpose only.
- Do not copy and use this content without authority.
- Please note if you add load over capacity, or add force from side or torsion, its sensor would be broken down.